

**CHINT**

CHINT ELECTRICS

NM8N Series  
MCCB  
User Instruction

**Zhejiang Chint Electrics Co., Ltd.**

Add: No.1, CHINT Road, CHINT Industrial Zone, North Baixiang,

Yueqing, Zhejiang 325603, P.R.China

E-mail: [global-sales@chint.com](mailto:global-sales@chint.com)

Website: <http://en.chint.com>



NO:2019.08

**CHINT**  
CHINT ELECTRICS

NM8N Series  
MCCB

---

# User Instruction

---

Standard: IEC/EN 60947-2

## Safety Warning

- ① Only professional technicians are allowed for installation and maintenance.
- ② It is strictly prohibited to install in the environment containing inflammable, explosive gas and moist condensation.
- ③ Do not touch the conductive part of the product during working.
- ④ Power must be turned off when the product installed and maintained.
- ⑤ The product should not be installed at places where corrosive gas medium may cause damage to metals and insulations.
- ⑥ To avoid accidents, the product must be installed strictly according to the instructions.

### 1 Usage Information

This user instruction specifies the normal working conditions, main specifications, technical parameters, overall and installation dimensions of the NM8N series moulded case circuit breakers.

It is applicable to NM8N series moulded case circuit breakers (hereinafter referred to as circuit breakers).

It is suitable for AC 50Hz/60Hz, rated voltage AC 690V and below or DC system of rated voltage 1250V and below, rated current up to 1600A and below. It can connect, disconnect and carry the rated working current.

and can reliably protect the line and the electrical equipment from the event of overload, short circuit and undervoltage. It can also be used as the protection of infrequent start, short circuit and undervoltage for the motor.

### 2 Model specifications and definitions

NM8	N	DC	-	250	S	TM	125	4C	OTHER
①	②	③		④	⑤	⑥	⑦	⑧	⑨

① Company code

② N:Design code

③ DC MCCB; Switch disconnector is SD;AC MCCB has no code

④ Frame size current

125:125A

250:250A

400:400A

630:630A

800:800A

1600:1600A

⑤ Breaking capacity code

B:25kA C:36kA S:50kA Q:70kA

H:100kA R:150kA

⑥ Release type code

M: Magnetic type for motor protection

TM: Thermal-magnetic type

EN: Basic electronic type for power distribution

EM: Standard electronic type for power distribution

ENM: Basic electronic type for motor protection

EMM: Standard electronic type for motor protection

⑦ Rated current code

125:16-20-25-32-40-50-63-80-100-125

250:125-160-180-200-225-250

400:250-315-350-400

630:250-315-350-400-500

800:500-630-700-800  
1600:800-1000-1250-1600

Note: The above is the thermal magnetic rated current, the electronic rated current is shown in Table 2.

⑧ Poles:

- 1P: 1-pole
- 2P: 2-pole
- 3P: 3-pole
- 4A: 4-pole, there is no over-current protection at pole N and N-pole does not operate with other three poles
- 4B: 4-pole, there is no over-current protection at pole N and N-pole operates with other three poles
- 4C: 4-pole, there is over-current protection at pole N and N-pole operates with other three poles
- 4D: 4-pole, there is over-current protection at pole N and N-pole does not operate with other three poles

⑨ Special requirement

- According to the corresponding special requirements
- 1600A motor type : MD AC230
- MD AC400
- MD DC110
- MD DC220

### 3 Conditions for Normal operation, Installation, Transportation and Storage

3.1 Conditions for normal operation

- Operating and storage temperature is -40° C~+70° C; the average value within 24 hours does not exceed +35° C; when the ambient temperature is -40° C~+70° C, users need to consider derating or temperature compensate.
- When the maximum temperature is +40°C, the relative humidity of the air does not exceed 50%, and at a lower temperature, higher relative humidity (for example, 90% at +20°C) is allowed. Special measures should be taken for condensation that occasionally occurs due to temperature changes.
- The altitude of the installation site should not exceed 2000m; Note: When the altitude exceeds 2000m, please use according to the altitude derating correction factor.
- Product inverse time characteristics and temperature compensation curve and altitude derating correction factor table are detailed in the product catalog.
- Pollution level 3;
- Installation category III.

3.2 Installation conditions

The circuit breaker should be installed according to this instruction, with vertical inclination no higher than 5°.

3.3 Conditions for transportation and storage

Applicable temperature range is -25°C to +55°C, in a short time, (within 24h) up to +70°C. The storage area should be ventilated, dry, and free from rain and snow and direct sunlight.

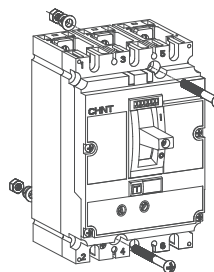

### 4 Inspection, testing

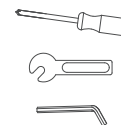

Necessary tool



Inspection

Model		
NM8N(DC)-125	1P	2(M3x70)
	2P	2(M5x65)
	3P	2(M5x65)
	4P	4(M5x65)
NM8N(DC)-250	1P	2(M3x85)
	2P	2(M5x75)
	3P	2(M5x75)
	4P	4(M5x75)
NM8N(DC)-400	3P	4(M5x85)
NM8N(DC)-360	4P	6(M5x85)
NM8N(DC)-800	3P	4(M5x95)
	4P	6(M5x95)
NM8N(DC)-1600	3P	4(M5x110)
	4P	6(M5x110)



1. Determine product technical parameters;
2. Only professional electricians are allowed for installation , operation and maintenance of the product.

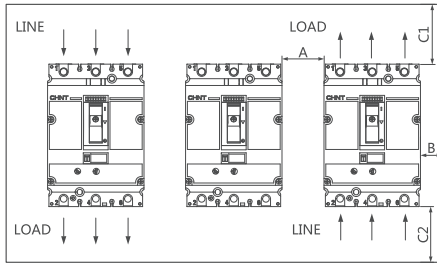

Model	Ue(V)	A	B	Insulation panel(mm)		Metal panel(mm)	
				C1	C2	C1	C2
NM8N-125	<660	10	10	30	30	35	35
	≥660		20	30	30	35	35
NM8N-250	<660		10	30	30	35	35
	≥660		20	30	30	35	35
NM8N-400 NM8N-630	<660		10	30	30	35	35
	≥660		20	30	30	35	35
NM8N-800	<660		10	130	130	170	170
	≥660		20	130	130	170	170
NM8N-1600	<660		10	130	130	170	170

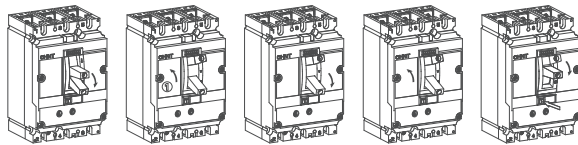

Re-trip      Closing      Opening      Closing      Tripping

Test



Ensure minimum installation distance

5 Overall and installation dimension

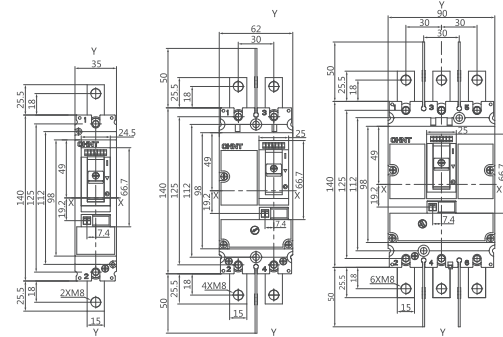

mm

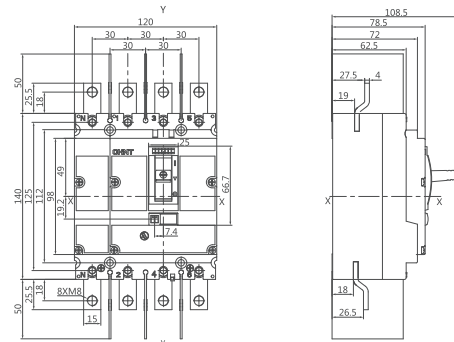

Diagram 1. NM8N(DC, SD)-125







## 6 Release

### 6.1 Thermo-magnetic type release

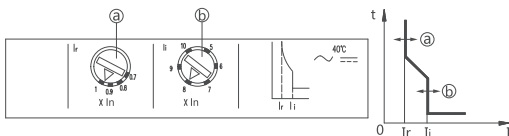

Ⓐ Overload protection setting adjustable

Ⓑ Short circuit protection setting adjustable

Example: Taking NM8N-250S TM 250A 3P as an example

Ⓐ: Long-time delay current setting knob

$I_r = 250A$

Ir 0.7 0.8 0.9 1.0

$I_r = 1.0 \times 250A (I_n) = 250A$

Ⓑ: Instantaneous current setting knob

Ii 5 6 7 8 9 10

$I_i = 8 \times 250A (I_n) = 2000A$

Table 2. Thermal magnetic trip setting

Size category	Size code	Thermal magnetic trip setting		N-pole protection	
		Overload protection (thermal)	Short circuit protection (magnetic)	4A, 4B	4C, 4D
NM8N-125	1P	$1.0I_n$	$10I_n$ (Power distribution) $12I_n$ (Motor protection)	No protection	Same as other three poles
	2P, 3P, 4P	$0.7 \sim 1.0I_n$			
NM8N-250	1P	$1.0I_n$	$10I_n$		
	2P, 3P, 4P	$0.7 \sim 1.0I_n$	$7 \sim 12I_n$ (Power distribution 125A) $5 \sim 10I_n$ (Power distribution 160-250A) $9 \sim 14I_n$ (Motor protection)		
NM8N-400/ 630/800	3P, 4P	$0.7 \sim 1.0I_n$	$5 \sim 10I_n$ (Power distribution) $9 \sim 14I_n$ (Motor protection)		
NM8N-1600		$0.7 \sim 1.0I_n$	$5 \sim 10I_n$ (Power distribution) $9 \sim 14I_n$ (Motor protection)		

### 6.2 Electronic type release

Table 3. Electronic type rated current

Frame size rated current $I_{nm}$	Rated current $I_n$
A	A
250	32, 63, 100, 160, 250
400	250, 400
630	250, 400, 630
800	630, 800
1600	800, 1000, 1250, 1600

#### 6.2.1 Basic electronic type release

Diagram 7. NM8N-250 EN 4C (Power distribution) Controller interface

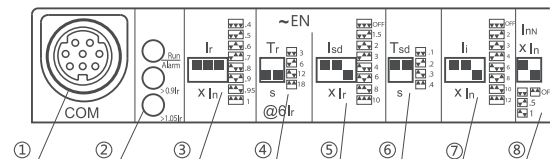

- ① Communication test interface: external communication module or dedicated handheld test equipment
- ② Status indicator: Under normal working status, the green working status indicator flashes. When the actual current  $I \geq 90\%I_r$ , the yellow warning light is on, and when  $I < 90\%I_r$ , the yellow warning light is off. When the actual current  $I \geq 105\%I_r$ , the red overload warning light is on, when  $I < 105\%I_r$ , the overload warning light is off.
- ③ Long-time delay current setting dial switch: long-time delay multiple setting, including  $(0.4-1)I_n$ , with a total of 8 gears
- ④ Long-time delay time setting dial switch: long-time delay time setting, including (3-18)s in total of 4 gears
- ⑤ Short-time delay current setting dial switch: short-time delay multiple setting, including  $(1.5-10)I_r + OFF$  in total of 8 gears
- ⑥ Short-time delay time setting dial switch: short delay time setting, including (100-400) ms in total of 4 gears
- ⑦ Instantaneous current setting dial switch: instantaneous multiple setting, including  $(2-12)I_n + OFF$  in total of 8 gears
- ⑧ N-pole setting dial switch: Neutral line multiple setting, including  $OFF + (0.5, 1)I_n + OFF$  a total of 4 gears. 3P products have no neutral line protection function and corresponding dial switch;

Diagram 8. NM8N-250 ENM 3P(Motor type)Controller interface

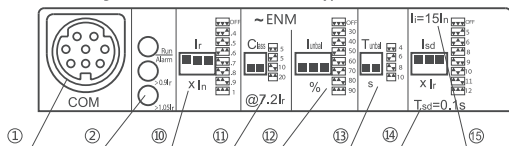

- ① Communication test interface: external communication module or dedicated handheld test equipment
- ② Status indicator: Under normal working status, the green working status indicator flashes. When the actual current  $I \geq 90\%I_r$ , the yellow warning light is on, and when  $I < 90\%I_r$ , the yellow warning light is off. When the actual current  $I \geq 105\%I_r$ , the red overload warning light is on, when  $I < 105\%I_r$ , the overload warning light is off.
- ③ Long-time delay current setting dial switch: long-time delay multiple setting, including  $(0.4-1)I_n$  with a total of 8 gears
- ④ Long-time delay protection tripping level dial switch: long-time delay protection trip level setting, including Class (5-10-20) with a total of 3 gears
- ⑤ Current phase unbalance rate setting dial switch: phase unbalance rate setting, including (30%-90%) + OFF with a total of 8 gears. If the overload long-time delay  $I_r$  is turned off, the phase unbalance / phase loss protection function automatically turns OFF.
- ⑥ Phase unbalance rate delay time setting dial switch: phase unbalance rate delay time setting, including (4-10) s a total of 4 gears
- ⑦ Short circuit short-time delay current setting dial switch, the customer can use the tool to dial according to actual needs, including OFF +  $(5-12)I_r$  with a total of 8 gears. The tripping time is set 0.1s as default, and is not adjustable. If the overload long-time delay  $I_r$  is turned off, the short circuit short-time delay protection setting protects according to the multiple of x In.
- ⑧ Short circuit instantaneous protection default setting  $I_i=15I_n$ , not adjustable OFF +  $(0.5, 1) I_n$  + OFF with a total of 4 gears, 3P products have no neutral line protection function and corresponding dial switch;

Diagram 9. NM8N-400, 630 EN 4C ( Power distribution ) Controller interface

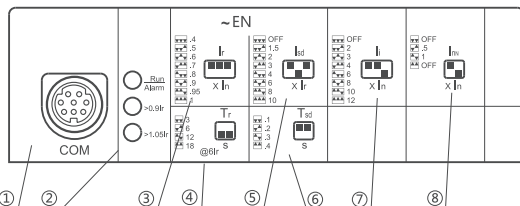

- ① Communication test interface: external communication module or dedicated handheld test equipment
- ② Status indicator: Under normal working status, the green working status indicator flashes. When the actual current  $I \geq 90\%I_r$ , the yellow warning light is on, and when  $I < 90\%I_r$ , the yellow warning light is off. When the actual current  $I \geq 105\%I_r$ , the red overload warning light is on, when  $I < 105\%I_r$ , the overload warning light is off.
- ③ Long-time delay current setting dial switch: long-time delay multiple setting, including  $(0.4-1)I_n$  with a total of 8 gears
- ④ Long-time delay time setting dial switch: long-time delay time setting, including (3-18)s in total of 4 gears
- ⑤ Short-time delay current setting dial switch: short-time delay multiple setting, including  $(1.5-10) I_r$  + OFF in total of 8 gears
- ⑥ Short-time delay time setting dial switch: short-time delay time setting, including (100-400) ms in total of 4 gears
- ⑦ Instantaneous current setting dial switch: instantaneous multiple setting, including (2-12)  $I_n$  + OFF in total of 8 gears
- ⑧ N-pole setting dial switch: Neutral line multiple setting, including OFF+  $(0.5, 1)I_n$  + OFF a total of 4 gears. 3P products have no neutral line protection function and corresponding dial switch;

Diagram 10. NM8N-400, 630 ENM 3P (Motor protection ) Controller interface

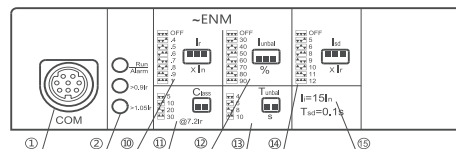

- ① Communication test interface: external communication module or dedicated handheld test equipment
- ② Status indicator: Under normal working status, the green working status indicator flashes. When the actual current  $I \geq 90\%I_r$ , the yellow warning light is on, and when  $I < 90\%I_r$ , the yellow warning light is off. When the actual current  $I \geq 105\%I_r$ , the red overload warning light is on, when  $I < 105\%I_r$ , the overload warning light is off.
- ③ Long-time delay current setting dial switch: long-time delay multiple setting, including  $(0.4-1)I_n$  + OFF, with a total of 8 gears
- ④ Long-time delay protection tripping level dial switch: long-time delay protection trip level setting, including Class (5-10-20-30) with a total of 4 gears
- ⑤ Current phase unbalance rate setting dial switch: phase unbalance rate setting, including (30%-90%) + OFF with a total of 8 gears. If the overload long-time delay  $I_r$  is turned off, the phase unbalance / phase loss protection function automatically turns OFF.
- ⑥ Phase unbalance rate delay time setting dial switch: phase unbalance rate delay time setting, including (4-10)s a total of 4 gears
- ⑦ Short circuit short-time delay current setting dial switch, the customer can use the tool to dial according to actual needs, including OFF +  $(5-12)I_r$  with a total of 8 gears. The tripping time is set 0.1s as default, and is not adjustable. If the overload long-time delay  $I_r$  is turned off, the short circuit short-time delay protection setting protects according to the multiple of x In.
- ⑧ Short circuit instantaneous protection default setting  $I_i=15I_n$ , not adjustable

Diagram 11. NM8N-800 EN 4C (Power distribution ) Controller interface

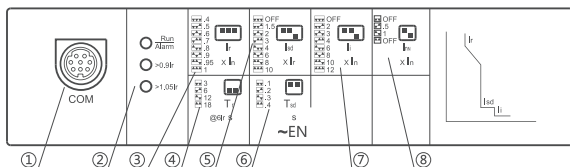

- ① Communication test interface: external communication module or dedicated handheld test equipment
- ② Status indicator: Under normal working status, the green working status indicator flashes. When the actual current  $\geq 90\%I_r$ , the yellow warning light is on, and when  $I < 90\%I_r$ , the yellow warning light is off. When the actual current  $\geq 105\%I_r$ , the red overload warning light is on, when  $I < 105\%I_r$ , the overload warning light is off.
- ③ Long-time delay current setting dial switch: long-time delay multiple setting, including  $(0.4-1)I_n$ , with a total 8 gears
- ④ Long-time delay time setting dial switch: long-time delay time setting, including  $(3-18)s$  in total of 4 gears
- ⑤ Short-time delay current setting dial switch: short-time delay multiple setting, including  $(1.5-10)I_r$  in total of 8 gears
- ⑥ Short-time delay time setting dial switch: short-time delay time setting, including  $(100-400)$  ms in total of 4 gears
- ⑦ Instantaneous current setting dial switch: instantaneous multiple setting, including  $(2-12)I_n$  in+OFF in total of 8 gears
- ⑧ N-pole setting dial switch: Neutral line multiple setting, including OFF+(0.5, 1) $I_n$ +OFF a total of 4 gears. 3P products have no neutral line protection function and corresponding dial switch;

Diagram 12. NM8N-800 ENM 3P (Motor protection ) Controller interface

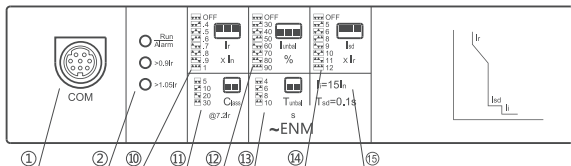

- ① Communication test interface: external communication module or dedicated handheld test equipment
- ② Status indicator: Under normal working status, the green working status indicator flashes. When the actual current  $\geq 90\%I_r$ , the yellow warning light is on, and when  $I < 90\%I_r$ , the yellow warning light is off. When the actual current  $\geq 105\%I_r$ , the red overload warning light is on, when  $I < 105\%I_r$ , the overload

warning light is off.

- ⑩ Long-time delay current setting dial switch: long-time delay multiple setting, including  $(0.4-1)I_n$  +OFF, with a total 8 gears
- ⑪ Long-time delay protection tripping level dial switch: long-time delay protection trip level setting, including Class  $(5-10-20)$  with a total 3 gears
- ⑫ Current phase unbalance rate setting dial switch: phase unbalance rate setting, including  $(30\%-90\%)$  + OFF with a total 8 gears. If the overload long-time delay Ir is turned off, the phase unbalance / phase loss protection function automatically turns OFF.
- ⑬ Phase unbalance rate delay time setting dial switch: phase unbalance rate delay time setting, including  $(4-10)$  s a total of 4 gears
- ⑭ Short circuit short-time delay current setting dial switch. the customer can use the tool to dial according to actual needs, including OFF +  $(5-12)I_r$  with a total of 8 gears. The tripping time is set 0.1s as default, and is not adjustable. If the overload long-time delay Ir is turned off, the short circuit short-time delay protection setting protects according to the multiple of  $I_n$ .
- ⑮ Short circuit instantaneous protection default setting  $I_i=15I_n$ , not adjustable

Diagram 13. NM8N-1600 EN 4P (Power distribution ) Controller interface

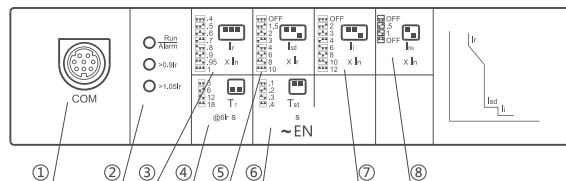

- ① Communication test interface: externally connect the battery box to supply power to adjust the controller parameters; external communication module or dedicated handheld test equipment
- ② Status indicator: Under normal working status, the green working status indicator flashes. When the actual current  $\geq 90\%I_r$ , the yellow warning light is on, and when  $I < 90\%I_r$ , the yellow warning light is off. When the actual current  $\geq 105\%I_r$ , the red overload warning light is on, when  $I < 105\%I_r$ , the overload warning light is off.
- ③ Long-time delay current setting dial switch: long-time delay multiple setting, including  $(0.4-1)I_n$ , with a total 8 gears
- ④ Long-time delay time setting dial switch: long-time delay time setting, including  $(3-18)s$  in total of 4 gears
- ⑤ Short-time delay current setting dial switch: short-time delay multiple setting, including  $(1.5-10)I_r$  in+OFF in total of 8 gears
- ⑥ Short-time delay time setting dial switch: short-time delay time setting, including  $(100-400)$  ms in total of 4 gears
- ⑦ Instantaneous current setting dial switch: instantaneous multiple setting, including  $(2-12)I_n$  in+OFF in total of 8 gears
- ⑧ N-pole setting dial switch: Neutral line multiple setting, including OFF+(0.5, 1) $I_n$ +OFF a total of 4 gears. 3P products have no neutral line protection function and corresponding dial switch;

6.2.2 Dialing function adjustment example

Example 1: Power-distribution type electronic molded case circuit breaker NM8N-250S EN 250A 4C

③ : Long-time delay current setting code switch

Neutral short circuit instantaneous protection  $I_i(N)=15XInN=3750A$

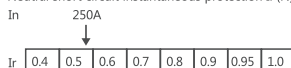

$I_r=0.6X250A(I_n)=150A$

④ Long-time delay time setting code switch: long delay time setting, including (3-6-12-18) s a total of 4 gears.

I	$\leq 1.05I_r$	1.3Ir	1.5Ir (s)				2Ir(s)				6Ir(s)			
Tr	> 2h non-tripping	< 1h tripping	3X16	6X16	12X16	18X16	3X9	6X9	12X9	18X9	3X1	6X1	12X1	18X1

⑤ Short-time delay current setting code switch

$I_r=0.6In=150A$

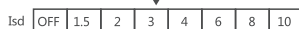

$I_{sd}=4X150A(I_n)=600A$

⑥ Short-time delay time setting code switch: short-time delay time setting, including (100-400) ms a total of 4 gears

⑦ Instantaneous current setting code switch



$I_i=6X250A(I_n)=1500A$

⑧ Neutral current setting switch

$I_n=250A$ ,  $I_{sd}=4I_r$ ,  $I_i=6In$

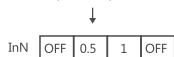

$I_nN=1.0X250A(I_n)=250A$

Neutral line overload long delay protection  $I_r(N)=InN=250A$

Neutral short circuit short delay protection  $I_{sd}(N)=4XInN=1000A$

Neutral short circuit transient protection  $I_i(N)=6XInN=1500A$

Example 2: Motor type electronic molded case circuit breaker NM8N-250S ENM 250A 3P

③ Long time delay current setting switch

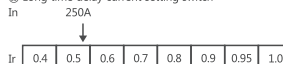

$I_r=0.6X250A(I_n)=150A$

④ Long time delay protection trip level dial switch: long time delay protection trip level setting, including Class (5-10-20) a total of 3 gears

Overload long time delay inverse time action characteristic table

I	$\leq 1.05I_r$	1.2Ir	2Ir(s)				7.2 Ir(s)			
Tr	> 2h non-tripping	< 2h tripping	Class5	Class10	Class20	Class30	Class5	Class10	Class20	Class30
T ( S )			52	104	208	311	4	8	16	24

⑤ Current phase imbalance setting switch: phase imbalance rate setting, including (30%-90%) + OFF total 8 gears

⑥ Phase unbalance rate delay time setting dial switch: phase unbalance rate delay time setting, including (4-6-8-10) s total 4 gears

⑦ Short time delay current setting dial switch (short delay time  $T_{sd}=0.1s$ , not adjustable)

$I_n=250A$ ,  $I_r=0.6In=150A$

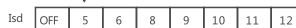

$I_{sd}=5X150A(I_r)=750A$

⑧ Instantaneous protection default setting  $I_i=15In$ , not adjustable

6.2.3 Standard electronic type release

Diagram 14. NM8N Series Power Distribution Protection EM and Motor Protection EMM Controller Interface and Operation Guide

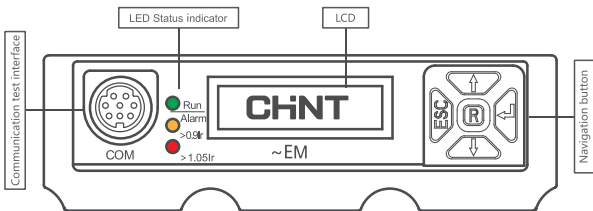

Note: EM is unit for power distribution; EMM is unit for motor protection

- ① Communication test interface: externally connect the battery box to supply power to adjust the controller parameters; external communication module or dedicated handheld test equipment
- ② Status indicator: Under normal working status, the green working status indicator flashes. When the actual current  $I \geq 90\%I_r$ , the yellow warning light is on, and when  $I < 90\%I_r$ , the yellow warning light is off. When the actual current  $I \geq 105\%I_r$ , the red overload warning light is on, when  $I < 105\%I_r$ , the overload warning light is off.
- ③ Liquid crystal display interface
- ④ Navigation keys: Up and down keys: page turning, changing status and values  
Left button (ESC): return to the previous interface, shift to the left  
Right button (confirm button): enter the next layer interface, confirm  
Middle button (R): return to the real-time current display interface

Real-time current cycle display

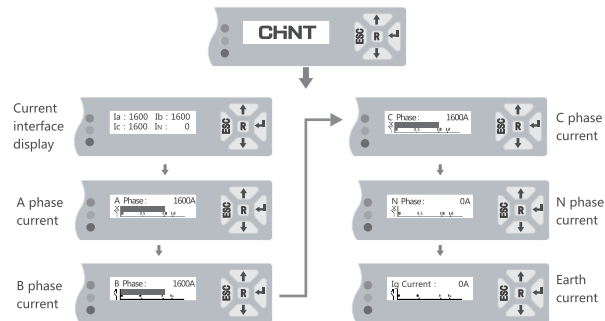

Main menu

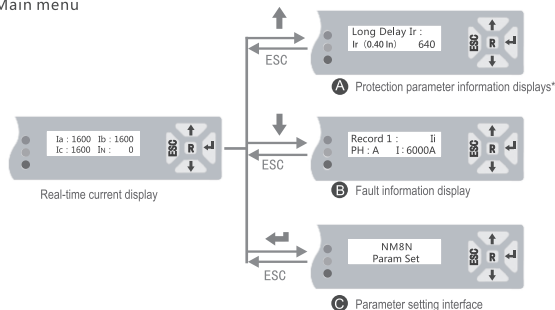

Note:

- A1.1 is the protection parameter information of the EM power distribution type unit;
- A1.2 is the protection parameter information of the EMM motor protection type unit;

**A1.1 EM Power distribution protection parameter inquiry**

For example: MN8N-1600SEM 4P, press the "\*" button in the current display interface to enter the query interface

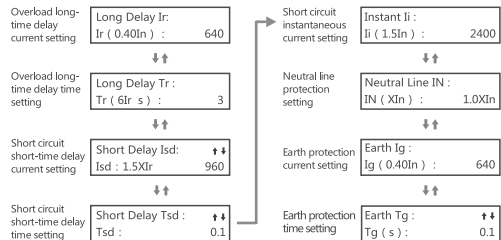

**A1.2 EMM Motor protection parameter inquiry**

For example: MN8N-800 EMM 3P, press the "\*" button in the current display interface to enter the query interface

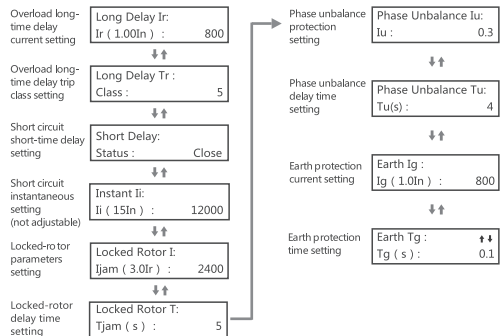

**B Fault information query**

Press the ↓ key in the current display interface to enter the fault information query interface, and the fault information can be recorded 3 times.

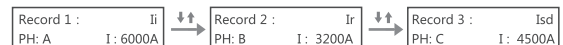

EM power distribution type smart unit fault type: long-time delay fault, short-time delay fault, instantaneous fault, ground fault;  
EMM motor protection type smart unit fault type: long-time delay fault, short-time delay fault, instantaneous fault, ground fault, locked-rotor fault, phase unbalance fault.

**C Parameter setting**

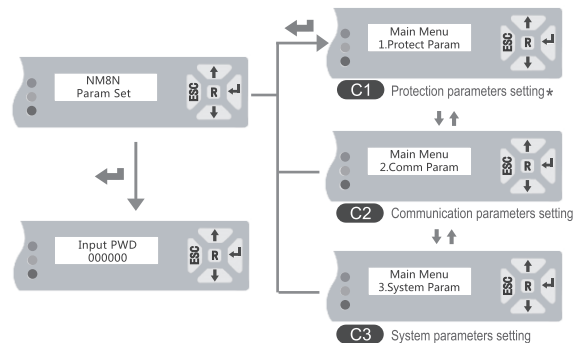

Note:  
C1.1 is the protection parameter information of the EM power distribution type unit;  
C1.2 is the protection parameter information of the EMM motor protection type unit;



### C1.1 EM power distribution protection parameter setting

Eq : NM8N-1600 EM 1600 4P , Enter the adjustment page by "←→", "↑↓" means it can be modified, "↑" and "↓" to adjust the value, "ESC" key cancels the change, "↵" to save the data after modification

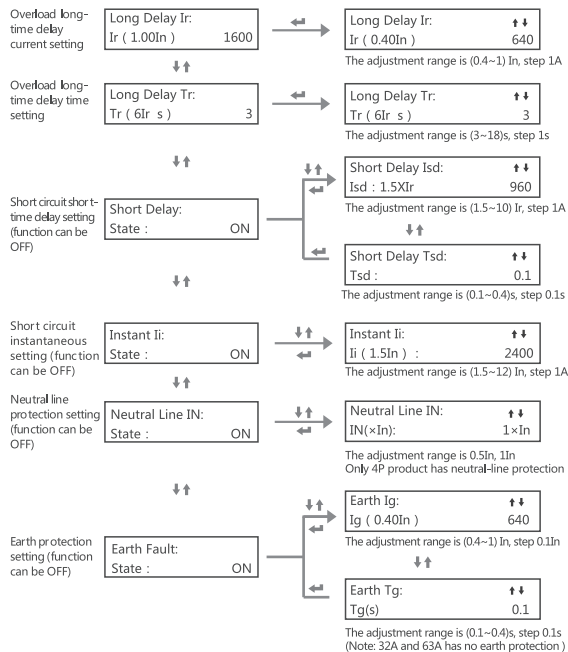

### C1.2 EMM motor protection parameter setting

Eq : NM8N-800H EMM 800 3P , Enter the adjustment page by "←→", "↑↓" means it can be modified, "↑" and "↓" to adjust the value, "ESC" key cancels the change, "↵" to save the data after modification

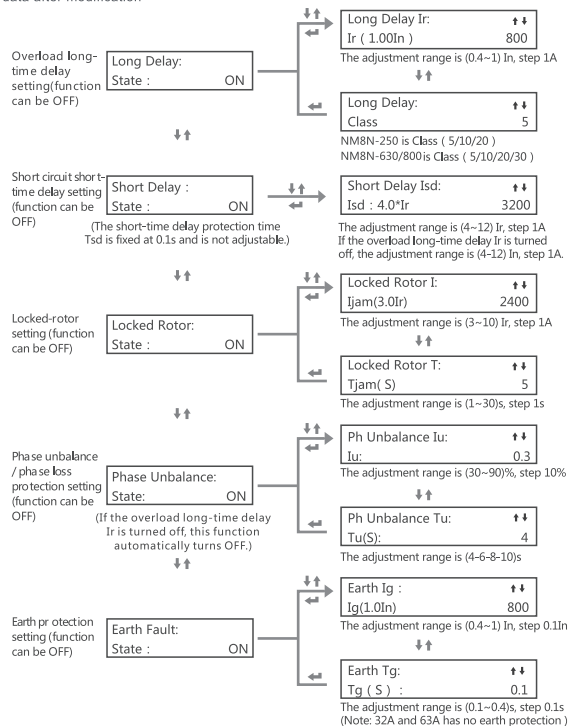

Note :

- EMM motor type instantaneous protection is fixed to 15In and is not adjustable.
- The EMM motor-type circuit breaker needs to be equipped with a contactor control module in order to be used as a two-device protection solution.
- When the two-device protection solution is applied, in the case of overload long-time delay protection, phase unbalance / phase loss protection, and locked-rotor protection, the pre-alarm function of the contactor control module can control the contactor to open 500ms before the circuit breaker opens. Short-time delay protection , instantaneous protection and ground fault protection is directly protected by the circuit breaker.
- During motor starting, the locked-rotor protection function is automatically turned off.
- During motor starting, the phase loss protection function automatically turns on. The contactor action delay time is 700ms. If the contactor fails, the circuit breaker will delay for another 500ms to open.

**C2** Communication parameter setting

Communication address setting	Comm Addr: Addr : 1	↔	Comm Addr: Addr : 1
	↓↑		↑↓
Communication baud setting	Comm Baud: Baud : 9600	↔	Comm Baud: Baud : 9600
	↓↑		↑↓
Network modification parameter setting	Net Mod Permit: State : OFF	↔	Net Mod Permit: State : ON
	↓↑		↑↓
Network control parameter setting	Net Ctrl Permit: State : OFF	↔	Net Ctrl Permit: State : ON

The adjustment range is from 1 to 247, the default is 1, and the super address is 250.

The adjustment range is 9600/19200bps, the default is 9600bps, and the communication mode defaults is SE1.

Can be set to "OFF" and "ON", the default function is ON, only in the ON state, the unit parameters can be adjusted by communication.

Can be set to "OFF" and "ON", the default function is ON, only in the ON state, The MCCB can be opened and closed in communication way.

**C3** System parameter setting

Interface language	LNG SEL : Type : Chinese	↔	LNG-SEL : Type : English
	↓↑		↑↓
Password setting	PWD SET : State : ON	↔	New PWD Set : ↑ : Esc    ↔ : Ent
	↓↑		↑↓
Software version query (example)	SVD Query : ke02v2.01909YP	↔	Set New PWD : 000000

It can set as "Simplified Chinese" and "English"

Adjustment range is 000000-999999

Notes:

- NM8N electronic trip unit is suitable for 50Hz/60Hz, rated voltage below 690V.
- The power supply of the electronic trip unit is powered by the built-in current transformer. When the main circuit current is  $\geq 0.4I_n$ , the electronic trip unit can work normally.
- The electronic trip system can view and modify the parameter settings by supplying power to the controller through an external dedicated battery box or hand-hold test equipment.
- Operating temperature -25 °C ~ +70 °C, storage temperature is -35 °C ~ +85 °C

**7** Installation, wiring

Connection plate and wire size

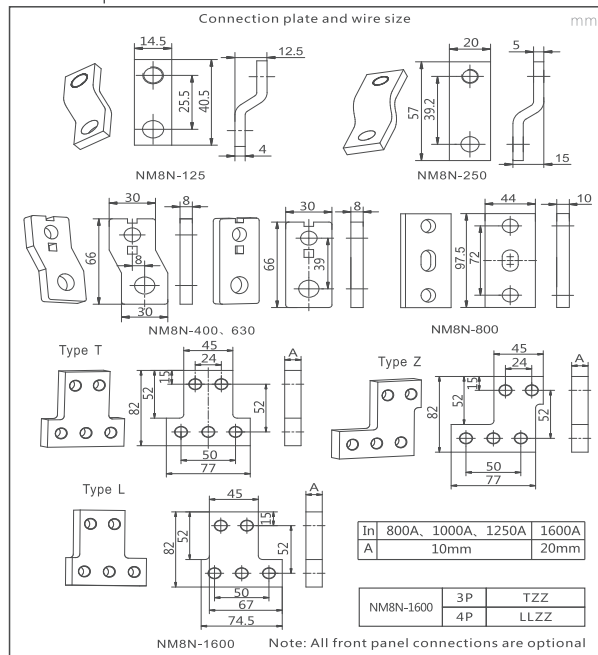

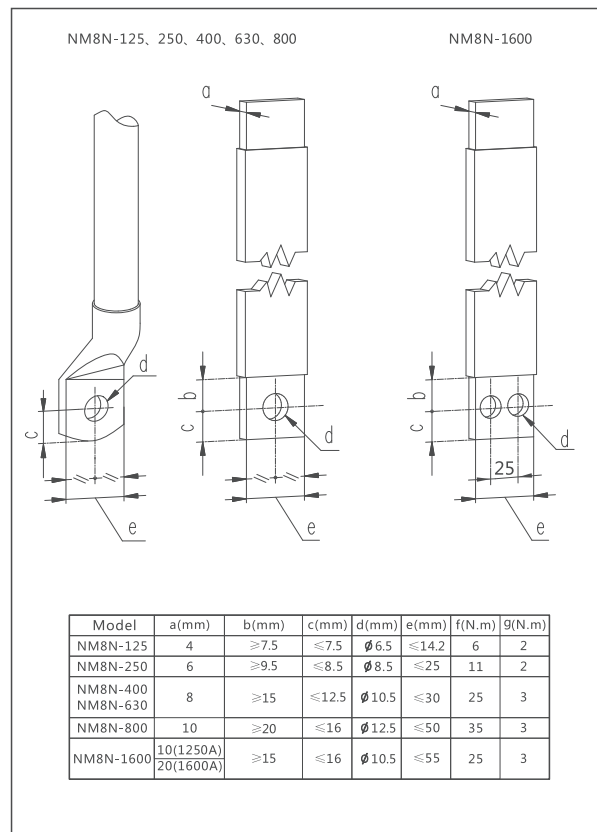
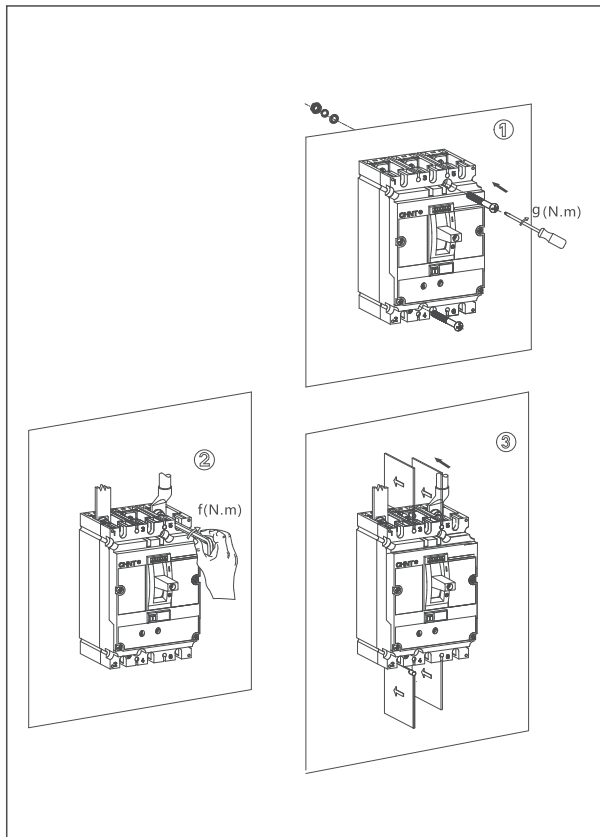

Solutions	Unipolar grounding system	Ungrounded system
≤DC500V	<p><b>Note:</b> 1. The upper and lower lines can be used, here the following lines are taken as an example.</p>	<p><b>Note:</b> 1. Both the upper and lower lines can be used, here the following lines are taken as an example; 2. Make sure that the installation method does not cause a secondary ground fault.</p>
DC500~750V	<p><b>Note:</b> 1. The upper and lower lines can be used, here the following lines are taken as an example.</p>	<p><b>Note:</b> 1. Both the upper and lower lines can be used, here the following lines are taken as an example; 2. Make sure that the installation method does not cause a secondary ground fault.</p>
DC750~1000V	<p><b>Note:</b> 1. The upper and lower lines can be used, here the following lines are taken as an example.</p>	

NM8NDC Wiring

DC Jumper

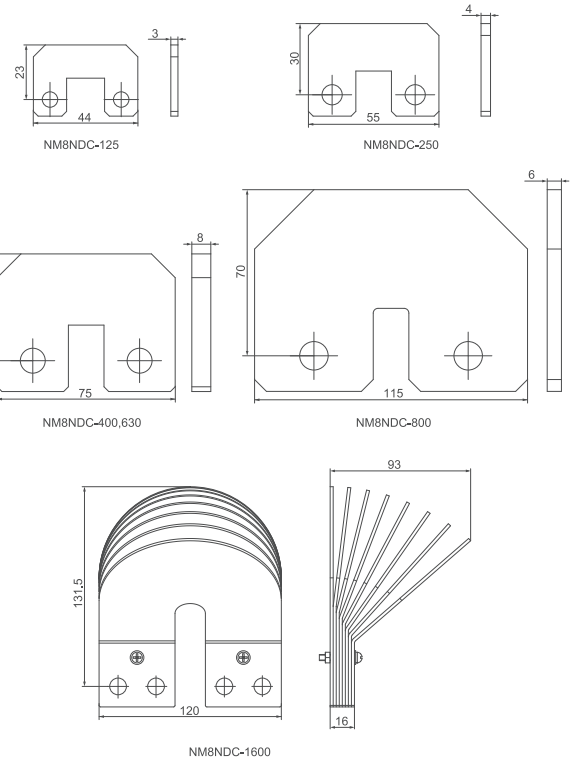

## 8 Environmental Protection

In order to protect the environment, the product or product parts should be disposed of according to the industrial waste treatment process, or be sent to the recycling station for assortment, dismantling and recycling according to local regulations.

---

CHNT

QC PASS

NM8N Series  
MCCB  
IEC/EN 60947-2

JZQ-08

Test date: Please see the packing

ZHEJIANG CHINT ELECTRICS CO., LTD.